

WS6282 User Manuals



Features:

- ▶ DCF Radio controlled clock function
- ▶ Radio control function can be switched ON and OFF
- ▶ Time in optional 12/24 hour format
- ▶ Perpetual Calendar Up to Year 2099
- ▶ Day of week in 7 languages user selectable: English, German, Italian, French, Spanish, Netherlands and Danish
- ▶ Dual Alarm clock can be set on weekdays / weekends and daily
- ▶ Snooze time setting (1~30Minute or OFF)
- ▶ Low battery indicate
- ▶ Indoor comfort indicator
- ▶ Weather forecasting and air pressure detect
- ▶ Ice alert
- ▶ Moon phase
- ▶ Window opening and closing prompt
- ▶ Remote sensor temperature alert range set
- ▶ Change trend display
- ▶ Humidity measurable range: 20%RH ~ 95%RH
- ▶ Temperature:
 - Indoor temperature measurement ranges: -9.9°C (14.2°F) ~ 50°C (122°F)
 - Outdoor temperature measurement ranges: -40°C (-40°F) ~ 70°C (158°F)
 - Temperature alternatively in °C or °F
- ▶ Maximum /minimum value record of temperature and humidity
- ▶ Wireless Outdoor Sensor:
 - 3 Channels selectable
 - 433.92MHz RF transmitting frequency
 - 60 meter transmission range in an open area
- ▶ Barometric pressure:
 - Barometric pressure measurement ranges: 850 ~ 1100 mB/hPa (25.10 ~ 32.48inHg)
 - Pressure alternatively in mB/hPa or inHg
- ▶ Power Supply:
 - Weather Station:

WS6282 User Manuals

Battery: 2 x LR03 AAA

Adapter: DC5V 600mA

Production Appearance

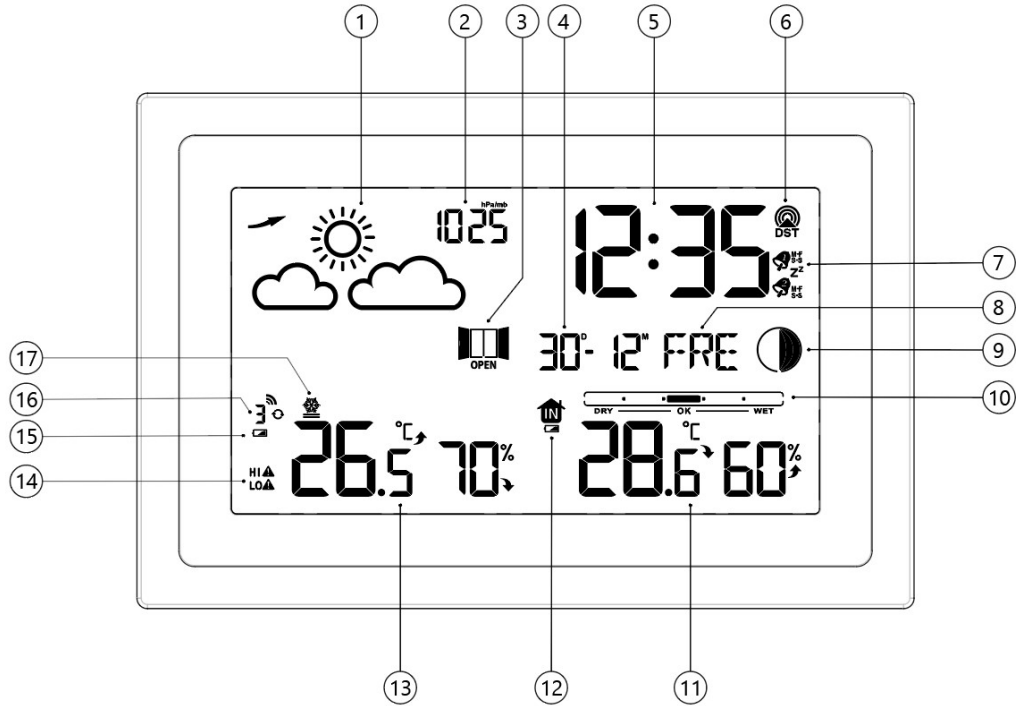

WS6282 User Manuals

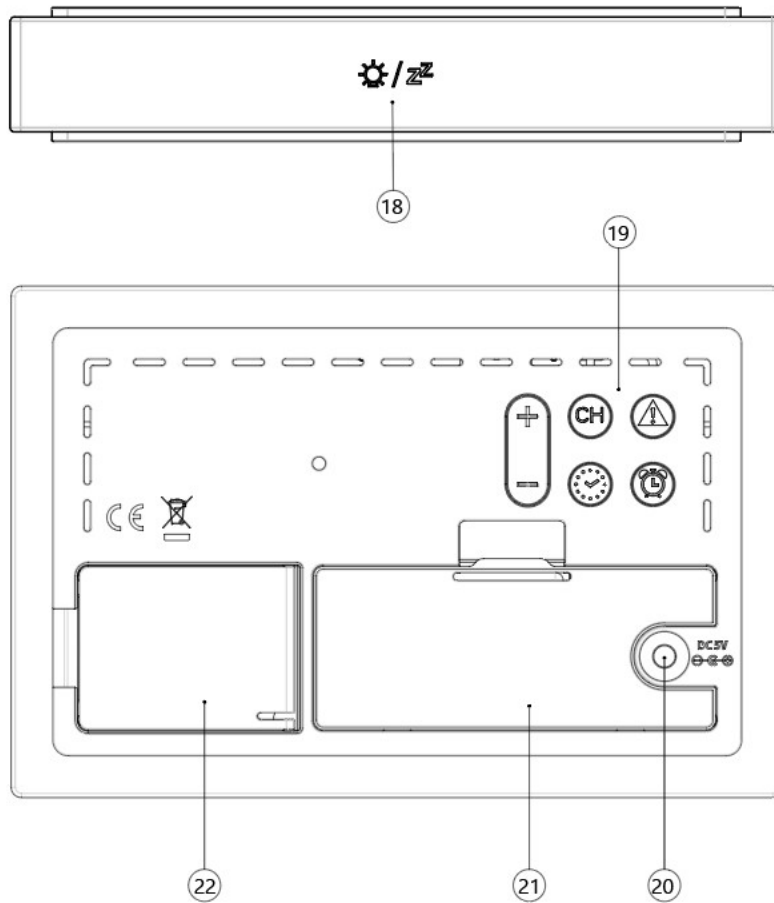

1. Weather forecast
2. Air pressure value
3. Window opening and closing prompt
4. Date
5. Time
6. Radio wave receiving status symbol
7. Alarm status indicator
8. Day of week
9. Moon phase
10. Indoor comfort indicator
11. INDOOR temperature and humidity value
12. Main unit low battery
13. Remote sensor temperature and humidity value
14. Remote sensor temperature alert status symbol
15. Remote sensor low battery indicator
16. Channel number
17. Ice alert
18. Light and snooze button



WS6282 User Manuals

19. Operation button
20. DC input jack
21. Battery compartment cover
22. Bracket

Initial operation:

- ▶ Open the main unit battery compartment cover
- ▶ Insert 2 x AAA batteries observing polarity [“+” and “ -” marks]
- ▶ When you insert the batteries, all icons on the LCD will light up for 3 seconds, and you will hear a beep tone, then detect indoor temperature & humidity.
- ▶ The main unit will now start to make a connection to the outdoor remote sensor. This process lasts for a maximum of 3 minutes and will be displayed by a flashing reception antenna symbol  In the upper right corner of the number of channels.
- ▶ This moment, Open the remote Sensor battery compartment cover, push the channel switch to select the number of channels to use, Insert 2 x AAA batteries according to the correct polarity **【Reference “+” and “-” marks】** , Press the “°C/°F” button to select the temperature unit you want, close the battery cover.
- ▶ After receiver has created a connection to the outdoor remote sensor, after up to 3 minutes it will enter the **DCF** Radio control time receive mode (The backlight will turn off during RC reception).
- ▶ The backlight will remain on after DCF reception is completed.

Reception of the Radio signal:

- ▶ Press and hold the **【-】** button to manually enter the **DCF** radio control receiving function, when the adapter is used for power supply, the backlight will be automatically and temporarily turned off after entering receiving mode. After receiving, it will automatically return to the previous backlight brightness.
- ▶ Enters **DCF** receiving mode, the symbol  will flashing, when a valid signal is detected the symbol  no flashing and switch to  is flashing, after about a few minutes, the receiving process will end.

: Received successfully

: The previous reception was successful, but the last reception failed

- ▶ At 1:00 /2:00 / 3:00 AM, the clock automatically carries out the synchronization procedure with the **DCF** signal to correct any deviations to the exact time. If this synchronization attempt is unsuccessful, the system will automatically attempt another synchronization at the next full one hour. This procedure is repeated automatically up to total 5 times.



WS6282 User Manuals

- ▶ During RC reception , to stop searching radio signal, press the 【-】 button once.

F.Y.I.:

- ▶ We recommend the product be placed at a minimum distance of 2.5 meters (8.2Feet) to all sources of interference, such as televisions or computer monitors or switching power adapter.
- ▶ Radio reception is weaker in rooms with concrete walls (e.g.: in cellars) and in offices. In such extreme circumstances, place the system close to the window.
- ▶ During the RC receive mode, only the 【Light/Snooze】 and 【-】 buttons have a function, other buttons are not functional, If you want to carry out other functions of operation, please press 【-】 button to exit the RC receiving mode.

Manual time setting:

- ▶ Press and hold the button  for 2 seconds, the “ ON/OFF ” starts to flash, and press 【+】 and 【-】 buttons to set the radio control function ON or OFF.
- ▶ Press button  to confirm the item has been set and go to the next one, the sequence of setting items is as follows:

RCC ON/OFF→DST ON/OFF→Time zone →12/24HR→ HOUR → MINUTE → Format of DATE (D/M or M/D) → YEAR → MONTH → DATE → Language of WEEK → Temperature Unit (°C/°F) →Pressure unit(hPa/mb or inHg)→ Current standard air pressure →Current weather

- ▶ When adjusting the value, press and hold the 【+】 or 【-】 button to adjust quickly.
- ▶ Press button  to confirm the last item to end the setting procedures, then it will return to the normal mode.
- ▶ When choosing the 12Hr format, if “PM” is displayed before the hours, it means that the hour is post meridiem.
- ▶ The 7 languages that show week abbreviations are listed below:









LANGUAGE	ENGLISH	GERMAN	FRENCH	SPANISH	ITALIAN	DUTCH	DANISH
DAY	ENG	GER	FRE	SPA	ITA	DUT	DAN
MONDAY	MON	MON	LUN	LUN	LUN	MAA	MAN
TUESDAY	TUE	DIE	MAR	MAR	MAR	DIN	TIR
WEDNESDAY	WED	MIT	MER	MIE	MER	WOE	ONS
THURSDAY	THU	DON	JEU	JUE	GIO	DON	TOR
FRIDAY	FRI	FRE	VEN	VE	VEN	VRI	FRE
SATURDAY	SAT	SAM	SAM	SAB	SAB	ZAT	LOR
SUNDAY	SUN	SON	DI	DOM	DOM	ZON	SON

WS6282 User Manuals

F.Y.I.:

- ▶ If there is no valid operation within 20 seconds, it will automatically return to normal time mode from the set mode.

Setting the daily alarms:

- ▶ Press **【-】** button, you can set Alarm1 and Alarm2 ON or OFF, symbol  appear means that ALARM1 is ON, symbol  appear means that ALARM2 is ON, symbol  or  disappear means that Corresponding ALARM is OFF.
- ▶ Press once button , LCD display Alarm1 time (5 seconds), press button  again when Alarm1 time is displayed, LCD display Alarm2 time (5 seconds), press button  again when Alarm2 time is displayed, return to current time display.
- ▶ When Alarm1 time is displayed, press and hold button  for 2 seconds until Hour of the Alarm1 time starts to flash, press the **【+】** or **【-】** buttons to set the required Hour.
- ▶ Press button  to confirm the item has been set and go to the next one, the sequence of setting items is as follows:

Hour of Alarm1 → Minute of Alarm1 → repeat period of Alarm1 → Snooze time of Alarm1

- ▶ When setting the repeat period, comply with the following rules:

M-F: From Monday to Friday

S-S: From Saturday to Sunday

M-F

S-S: From Monday to Sunday

- ▶ The snooze time can be set to 1-30 minutes or OFF, if “**OFF**” is selected, it means that the snooze function is turned off.
- ▶ The Alarm2 time can be set according to the same method above

F.Y.I.:

- ▶ If there is no valid operation within 20 seconds, it will automatically return to normal time mode from the alarm time set mode.
- ▶ When adjusting the value, press and hold the **【+】** or **【-】** button to adjust continuously and quickly
- ▶ The Alarm will sound for 2 minutes if you do not deactivate it by pressing any button.

Turn OFF the alarm sound



- ▶ When it's ringing, press any button except the **【SNOOZE】** button to stop the Alarm sound.
- ▶ When it's ringing, touch and hold the **【SNOOZE】** button for 2 seconds to stop the Alarm sound.

WS6282 User Manuals

Snooze function

- ▶ When it's ringing, touch the **【SNOOZE】** button once the alarm sounds to get to snooze mode, when the set snooze time is over, it will ring again.

RF Transmission Procedure

- ▶ The main unit automatically starts receiving transmission from remote sensor for temperature & humidity after batteries inserted.
- ▶ The remote sensor will automatically transmit temperature and humidity data to the main unit after batteries inserted.
- ▶ If the main unit failed to receive transmission from remote sensor (“-.-” and “--” display on the LCD), Press and hold the **【CH】** button for 2 seconds, RF icon  will be flashing, the main unit will rescan the launch signal of the channel.
- ▶ The main unit receive remote signals of up to 3 channels, press **【CH】** button to switch and display data of different channels, when the symbol  appears, the data of different channels will be displayed automatically every 5 seconds.

Maximum / Minimum numerical value of memory









- ▶ When the temperature and humidity are shown in the LCD, the main unit began to record temperature/ humidity maximum and minimum numerical value.
- ▶ Press once **【+】** button, the LCD will display maximum value of temperature/ humidity, The LCD will display the minimum value of temperature / humidity if press once **【+】** button again when the maximum value is displayed.
- ▶ at the same time, there are “**MAX**” or “**MIN**” displayed on the LCD.
- ▶ The maximum / minimum value will RE records after press and hold **【+】** button 3 seconds.
- ▶ The memory value of the day will be automatically cleared at 0:00 every night.

Weather forecasting function

Warning: Please take the weather forecast from your local weather forecasting service into account as well as the forecast from your weather station. If there are discrepancies between the information from your device and from the local weather forecasting service, please take the advice of the latter as authoritative.











- ▶ The weather forecast is calculated from evaluation of fluctuations in the barometric pressure and may deviate from the actual weather conditions.
- ▶ The weather station displays the following weather symbols:

WS6282 User Manuals

Sunny		
Slightly cloudy		
Cloudy		-----
Rainy		
Snowy		

Moon phase

▶ The weather station automatically displays the current lunar phase





									
New moon	Waxing half-moon	Half-moon	Waxing full moon	Full moon	Waning full moon	Half-moon	Waning half-moon		



Ice alert

▶ The ice Alert symbol  appears and flashing when the remote sensor temperature at $-1.0 \sim 2.9^{\circ}\text{C}$ ($30.2 \sim 37.3^{\circ}\text{F}$).

Outdoor temperature Alert

▶ Press button , you can set the Outdoor temperature alert function ON or OFF, this operation is only valid for the currently displayed channel, if you want to set other channels, press the **【CH】** button to switch to the channel display you want to set. When the symbol

HI  appear means that over upper limit alert function is ON, symbol **LO**  appear means that over lower limit alert function is ON, symbol **HI**  or **LO**  disappear means that Outdoor temperature alert function is OFF.

▶ Press and hold  button for 2 seconds, enter the outdoor temperature upper limit or lower limit value setting mode, the set item will flash, press the **【+】** or **【-】** buttons to set the value, press  button to confirm the item has been set and go to the next one, press the **【CH】** button to set the value of other channels.

▶ When the outdoor temperature exceeds the limit set by the channel, the temperature

WS6282 User Manuals

value and corresponding icon will be flash, and when the temperature is refreshed, as long as the temperature still exceeds the set limit, there will be a beep reminder.

Comfort level

Different levels of display are calculated according to the formula:

Humidity	< 35%	35~44%	45~65%	66~80%	> 80%

Window opening and closing prompt

▶ After complex calculation and comparison of indoor and outdoor absolute humidity, the system will use symbols to remind users whether they need to open or close windows.



----- It is recommended to open the window

CLOSE



----- It is recommended to close the window

Trend displaying

- ▶ The current temperature/humidity/barometric pressure and the temperature/humidity/barometric pressure trend are shown in the LCD display.
- ▶ After successfully connecting with the remote sensor, the main unit can display the outdoor temperature/ humidity and the change trend.

Background lighting

- ▶ When the adapter is used for power supply, press the button can adjust the backlight brightness.
- ▶ After the backlight is dimmed, touch the **【SNOOZE/LIGHT】** button once to jump to the brightest backlight for 15 seconds.
- ▶ When the product is powered only by battery (without adapter), touch the **【SNOOZE/LIGHT】** button once to turn on the backlight for 15 seconds.

ABOUT AC/DC POWER SUPPLY

Do not use the device:

- if the power supply or the power cable is damaged,
- in the event of a malfunction,
- if the device has been damaged in any way.

Never use sharp objects to access the inside of the power supply. Do not disassemble the

WS6282 User Manuals

power supply, do not throw it into a fire. Do not attempt to disassemble or modify this product or any of its components. Do not expose the food to high temperatures or direct sunlight. Do not incinerate it. Do not install the power supply near any heat sources, such as a radiator, hot air supply, oven, or other apparatus (including amplifiers) that produce heat. Do not store this product in a place where the temperature exceeds the following range: - 10 to 70 ° C. Do not use this product in a location where the temperature exceeds the following range: 0 to 40 ° C, as this may damage it or shorten its life. Do not place the power supply near water or a source of moisture, such as a bathtub, kitchen sink, swimming pool, in a wet basement, or other damp locations. The device must not be exposed to splashes. Do not place objects filled with water, such as vases for example, near the appliance. Connect the power supply into an easily accessible DC outlet. Ensure that the power cord can not be crushed or pinched, particularly at plugs, convenience receptacles, and the point where they are connected to the apparatus. The supplied power supply is intended for indoor use only. Do not place naked flame sources (such as a lit candle) on or near the power supply. Unplug this power during lightning storms or during long periods of non-use to avoid damage. Turn off your device before disconnecting the power cable. This device is not intended for use by people (including children) whose physical, sensory or mental capabilities are reduced, or people without experience or knowledge, unless they could benefit ,by the” throung a person responsible for their safety, surveillance or prior instructions concerning the use of the device. Children should be supervised to make sure that they do not play with the device. If the power supply works abnormally, and especoally if it emits sounds or odors that you think are abnormal, unplug it immediately and have it examined by a qualified repairer. The socket-outlet must be installed near the equipment and must be easily accessible.

LIABILITY DISCLAIMER :

- The electrical and electronic wastes contain hazardous substances. Disposal of electronic waste in wild country and/or in unauthorized grounds strongly damages the environment.
- Please contact your local or/and regional authorities to retrieve the addresses of legal

WS6282 User Manuals

dumping grounds with selective collection.

- All electronic instruments must from now on be recycled. User shall take an active part in the reuse, recycling and recovery of the electrical and electronic waste.
- The unrestricted disposal of electronic waste may do harm on public health and the quality of environment.
- As stated on the gift box and labeled on the product, reading the “User manual” is highly recommended for the benefit of the user. This product must however not be thrown in general rubbish collection points.
- The manufacturer and supplier cannot accept any responsibility for any incorrect readings and any consequences that occur should an inaccurate reading take place.
- This product is designed for use in the home only as indication of the temperature.
- The plug on the power adapter (if included) is intended to serve as the disconnect device, the socket-outlet shall be installed near the equipment and shall be easily accessible.
- This product is not to be used for medical purposes or for public information.
- The specifications of this product may change without prior notice.
- This product is not a toy. Keep out of the reach of children.
- No part of this manual may be reproduced without written authorization of the manufacturer.



RED DIRECTIVE 2014/53/EU

Summary of the Declaration of Conformity: We hereby declare that this wireless transmission device does comply with the essential requirements of RED Directive 2014/53/EU.

LA CROSSE TECHNOLOGY

6 A RUE DU COMMERCE

67118 GEISPOLSHHEIM

FRANCE